

Standard Floor

Pannello isolante / Insulating panel

Pannello / Panel 1100 x 600 H 10

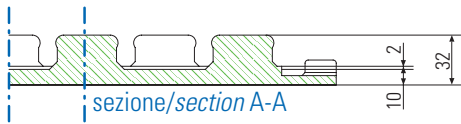

Pannello / Panels 1100 x 600 H 30

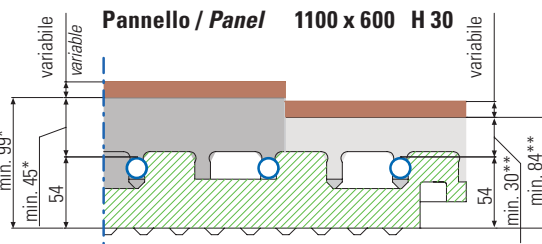
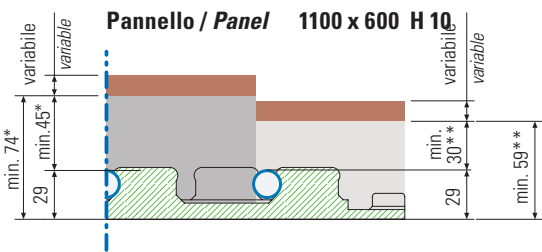
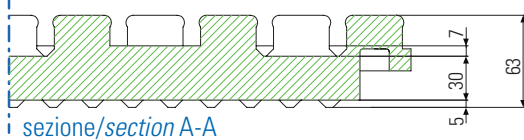

Modello H = 10 / Model H = 10

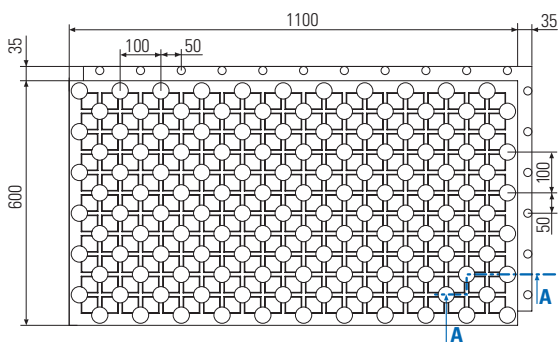

Modello H = 50 / Model H = 50

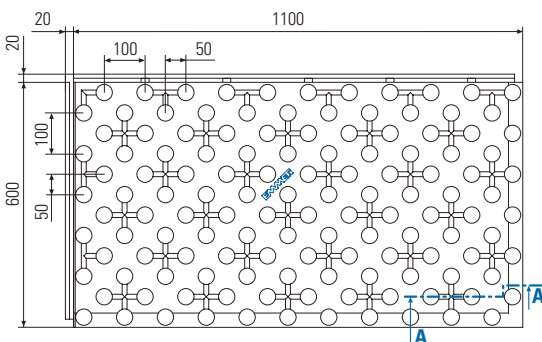

Ingombri minimi del sistema per edifici civili (mm)
Minimum system clearances for civil buildings (mm)

Pannello / Panel 1100 x 600 H 20

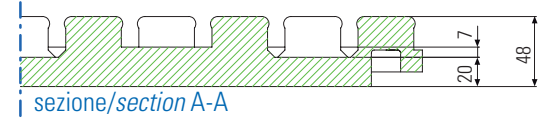

Pannello / Panels 1100 x 600 H 50

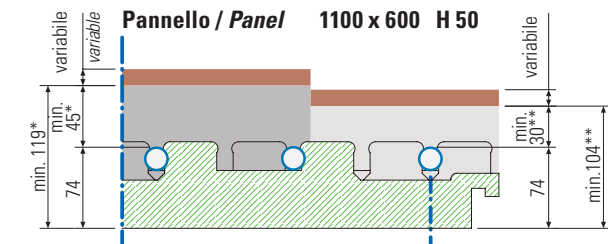
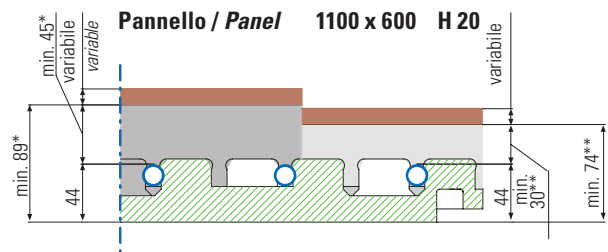
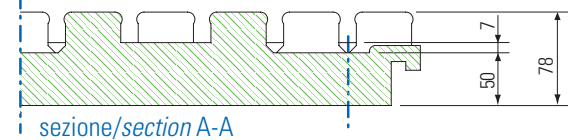

Modelli H = 20/30 / Model H = 20/30

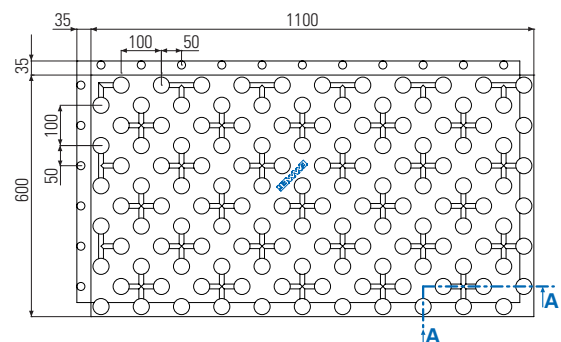

* Massetto cementizio tradizionale
Traditional concrete slab

** Massetto autolivellante
Self-levelling slab

Nota I massetti non vengono forniti da Emmeti
The slabs are not provided by Emmeti

Standard Combi Floor

Pannello isolante / *Insulating panel*

Ingombri minimi del sistema per edifici civili (mm)
Minimum system clearances for civil buildings (mm)

Pannello/panel 1100 x 600 H 10
 sezione/section A-A

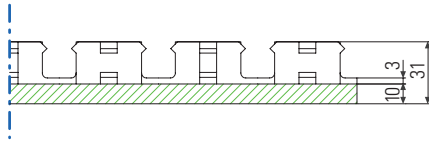

Pannello/panel 1100 x 600 H 20
 sezione/section A-A

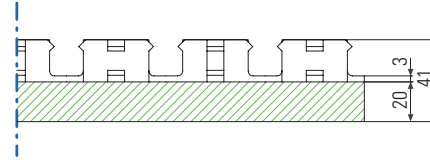

Pannello/panel 1100 x 600 H 30
 sezione/section A-A

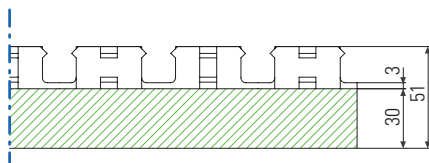

Pannello/panel 1100 x 600 H 10

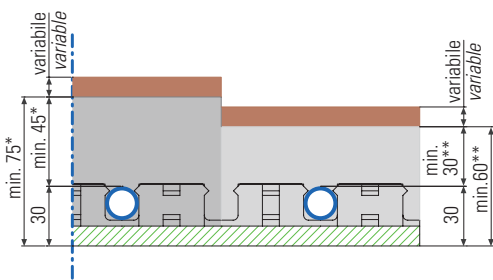

Pannello/panel 1100 x 600 H 20

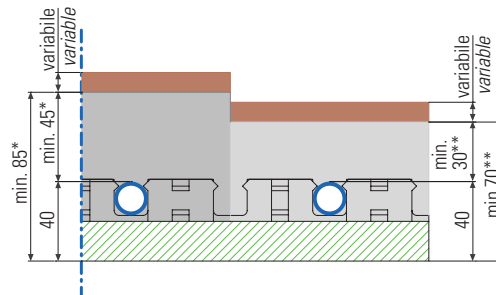

Pannello/panel 1100 x 600 H 30

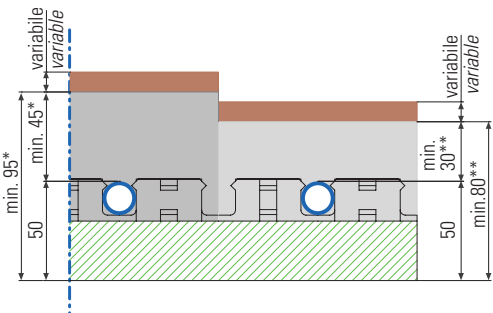

* Massetto cementizio tradizionale
Traditional concrete slab

** Massetto autolivellante
Self-levelling slab

Nota I massetti non vengono forniti da Emmeti
The slabs are not provided by Emmeti

Modelli H = 10/20/30
 Models H = 10/20/30

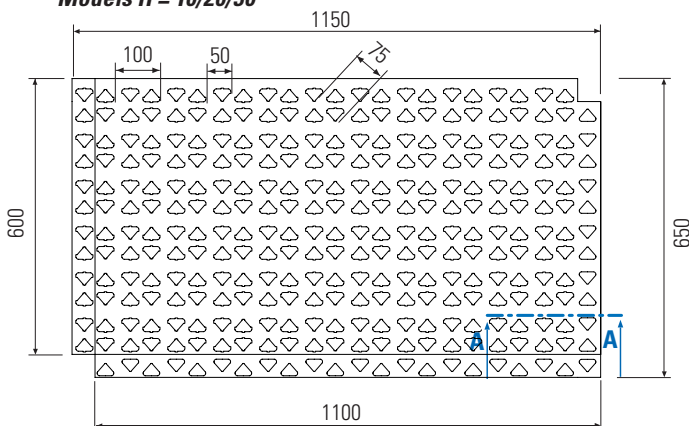

Classic Floor

Pannello isolante / *Insulating panel*

Ingombri minimi del sistema per edifici civili (mm)
Minimum system clearances for civil buildings (mm)

Pannello/panel 1200 x 750 H 20
 sezione/section A-A

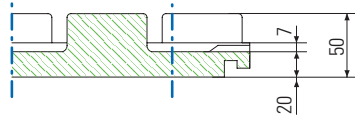

Pannello/panel 1200 x 750 H 30
 sezione/section A-A

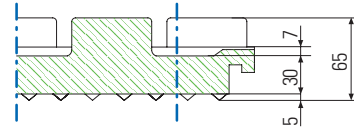

Pannello/panel 1200 x 750 H 20

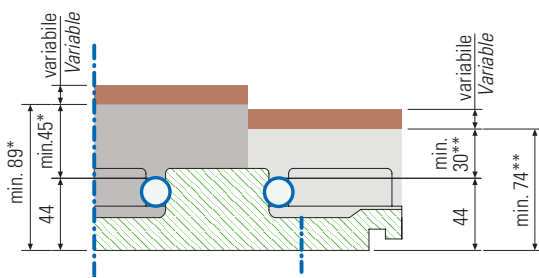

Pannello/panel 1200 x 750 H 30

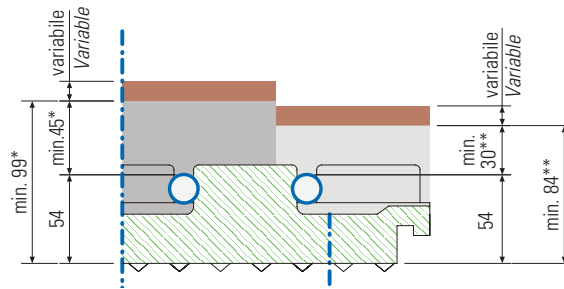

Modelli H = 20/30
Models H = 20/30

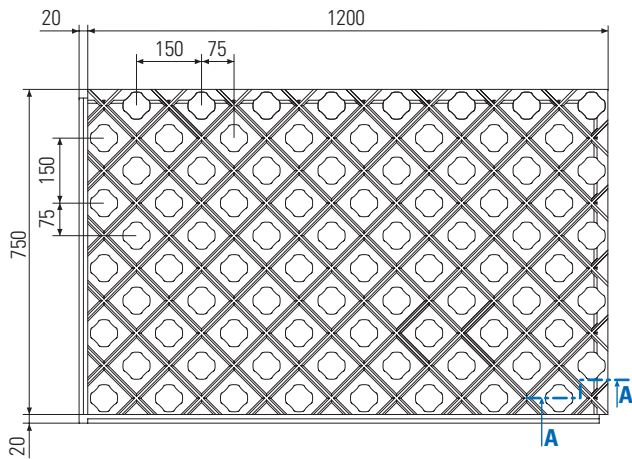

* Massetto cementizio tradizionale
Traditional concrete slab

** Massetto autolivellante
Self-levelling slab

Nota I massetti non vengono forniti da Emmeti
The slabs are not provided by Emmeti

Step Floor

Pannello fono-isolante / *Phono-insulating panel*

Ingombri minimi del sistema per edifici civili (mm)
Minimum system clearances for civil buildings (mm)

Pannello/panel 1000x500 H 30
 sezione/section A-A

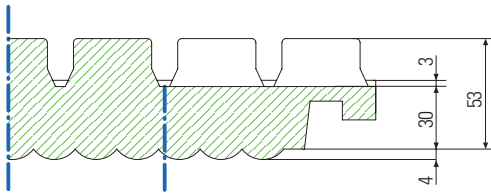

Pannello/panel 1000x500 H 30

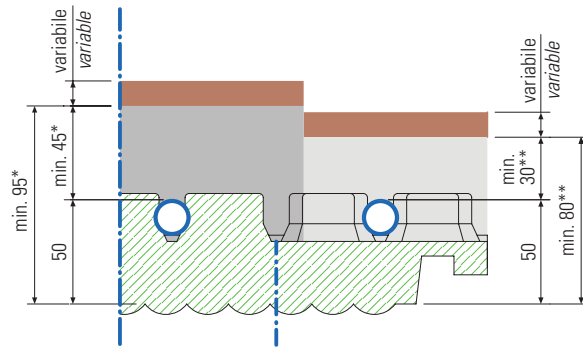

Modello H = 30
 Modell H = 30

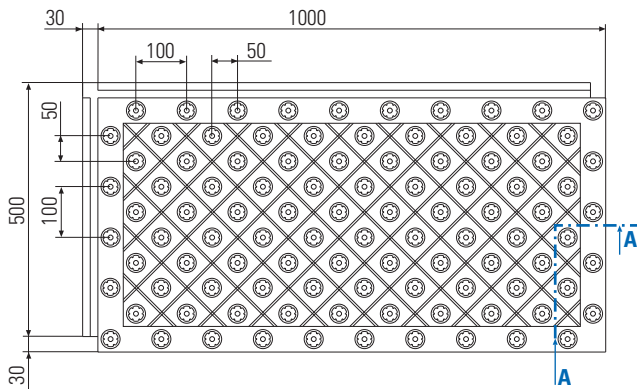

- * Massetto cementizio tradizionale
Traditional concrete slab
- ** Massetto autolivellante
Self-levelling slab

Nota I massetti non vengono forniti da Emmeti
The slabs are not provided by Emmeti

Step Combi Floor

Pannello fono-isolante / Phono-insulating panel

Pannello/panel 1400x800 H 35

sezione/section A-A

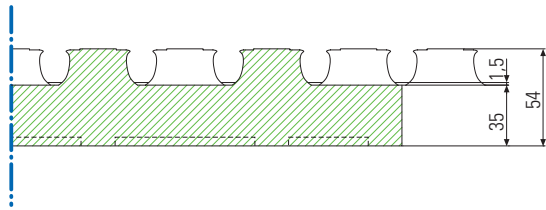

Modello H = 35
Modell H = 35

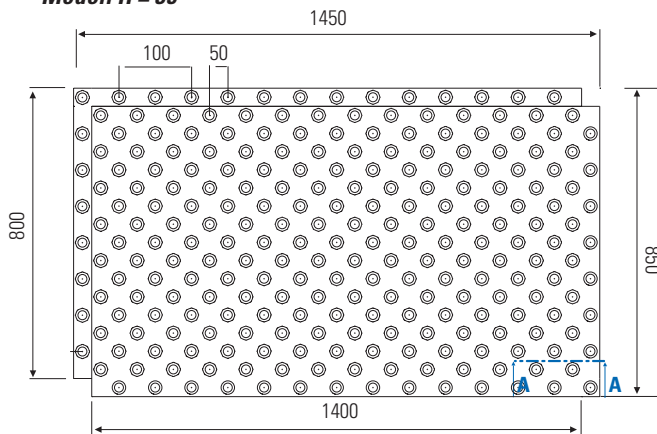

Ingombri minimi del sistema per edifici civili (mm)
Minimum system clearances for civil buildings (mm)

Pannello/panel 1400x800 H 35

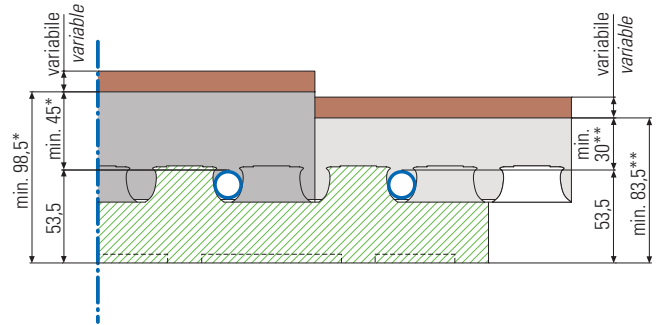

* Massetto cementizio tradizionale
Traditional concrete slab

** Massetto autolivellante
Self-levelling slab

Nota I massetti non vengono forniti da Emmeti
The slabs are not provided by Emmeti

Plan Floor

Pannello isolante / Insulating panel

Pannello/Panel 1100x600 H 30

sezione/section A-A

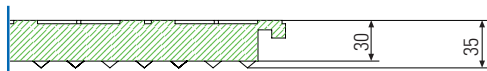

Modello H = 30
Modell H = 30

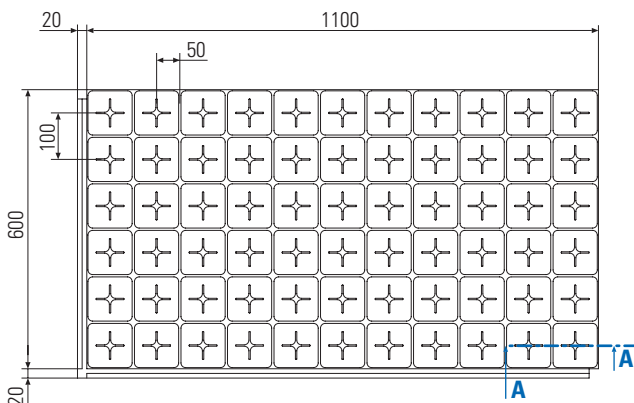

Ingombri minimi del sistema per edifici civili (mm)
Minimum system clearances for civil buildings (mm)

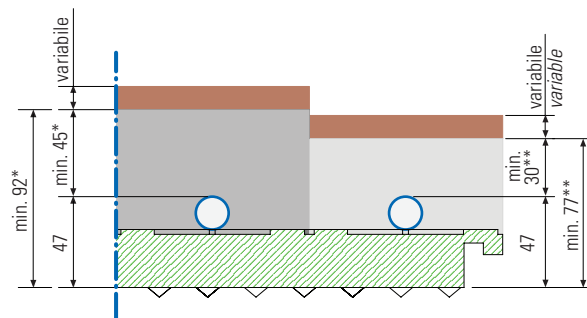

* Massetto cementizio tradizionale
Traditional concrete slab

** Massetto autolivellante
Self-levelling slab

Nota I massetti non vengono forniti da Emmeti
The slabs are not provided by Emmeti

Bio Combi Floor

Pannello isolante / *Insulating panel*

Pannello/panel 1000 x 500 H 20
sezione/section A-A

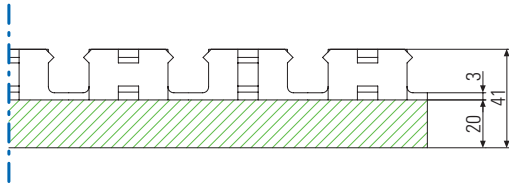

Pannello/panel 1000 x 500 H 30
sezione/section A-A

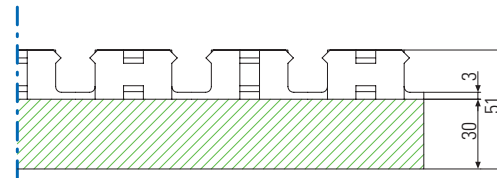

Pannello/panel 1000 x 500 H 20

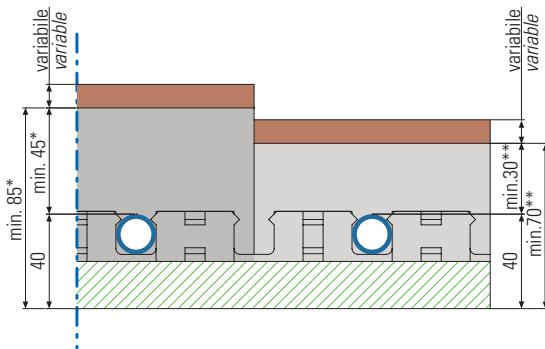

Pannello/panel 1000 x 500 H 30

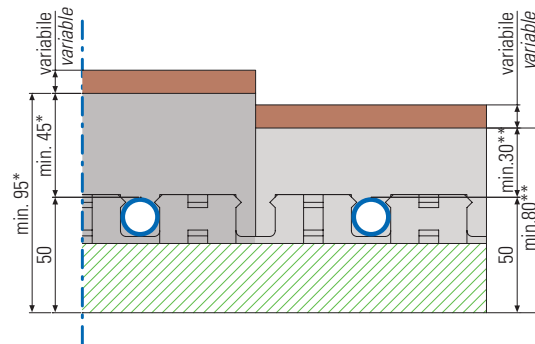

Modello H = 20/30
Modell H = 20/30

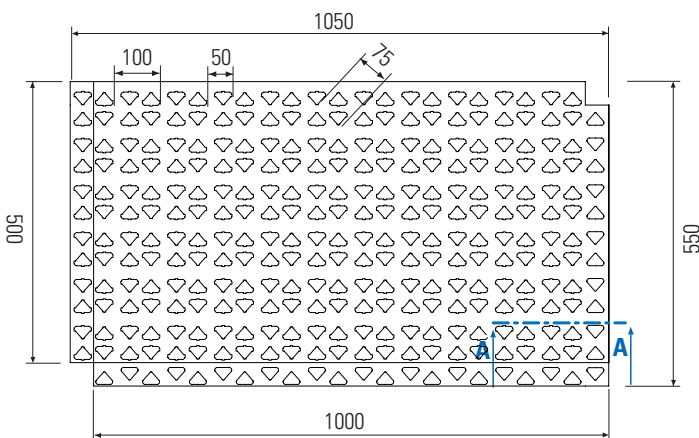

* Massetto cementizio tradizionale
Traditional concrete slab

** Massetto autolivellante
Self-levelling slab

Nota I massetti non vengono forniti da Emmeti
The slabs are not provided by Emmeti



Dry Alu Floor

Pannello isolante / *Insulating panel*

Dimensioni (mm) pannello H10 / H20

Dimension (mm) panel H10 / H20

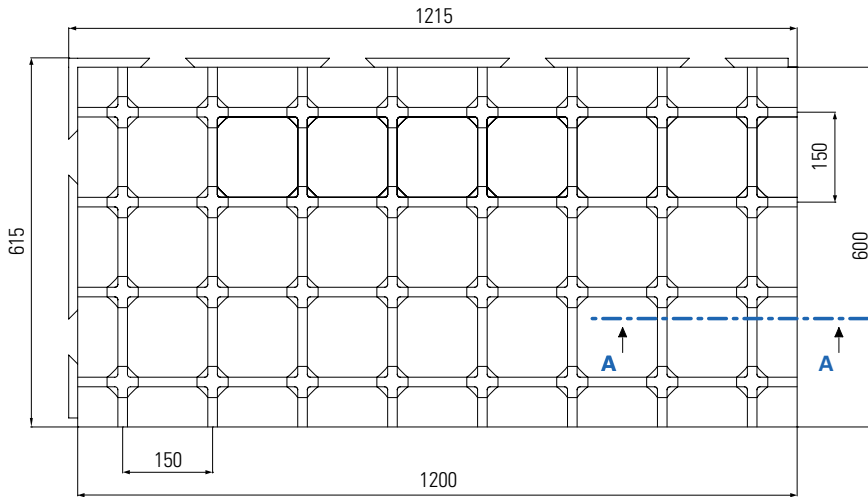

Pannello/panel 1200 x 600 H 10

sezione/section A-A

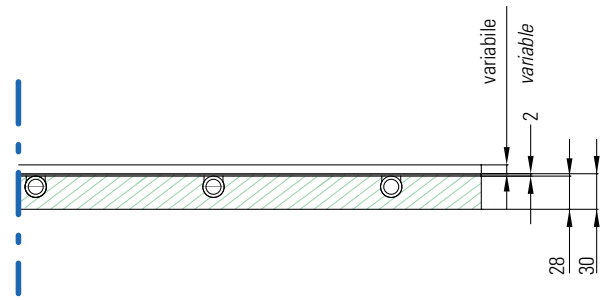
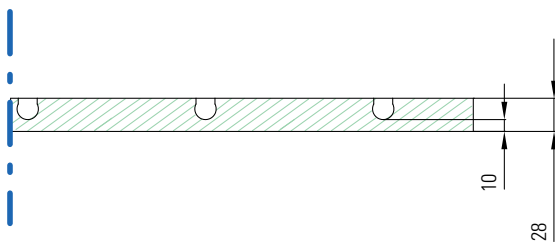

Pannello/panel 1000 x 600 H 20

sezione/section A-A

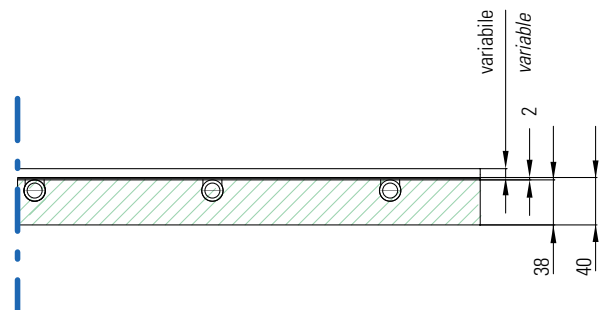
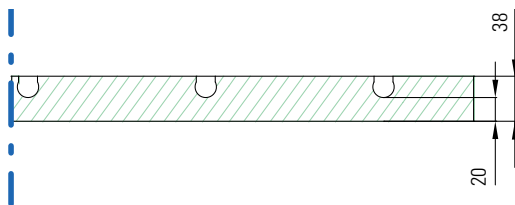

Ingombri minimi del sistema per edifici civili, con doppio strato di lamiera zincata per ripartizione carico (mm)

Minimum system clearances for civil buildings with double layer of galvanized steel for load distribution (mm) (mm)

Ingombri minimi del sistema per edifici civili, con doppio strato di lamiera zincata per ripartizione carico (mm)

Minimum system clearances for civil buildings with double layer of galvanized steel for load distribution (mm) (mm)

New

Dry Alu Floor

Pannello isolante di testa / *Insulation board head*

Dimensioni (mm) pannello H10 / H20

Dimension (mm) panel H10 / H20

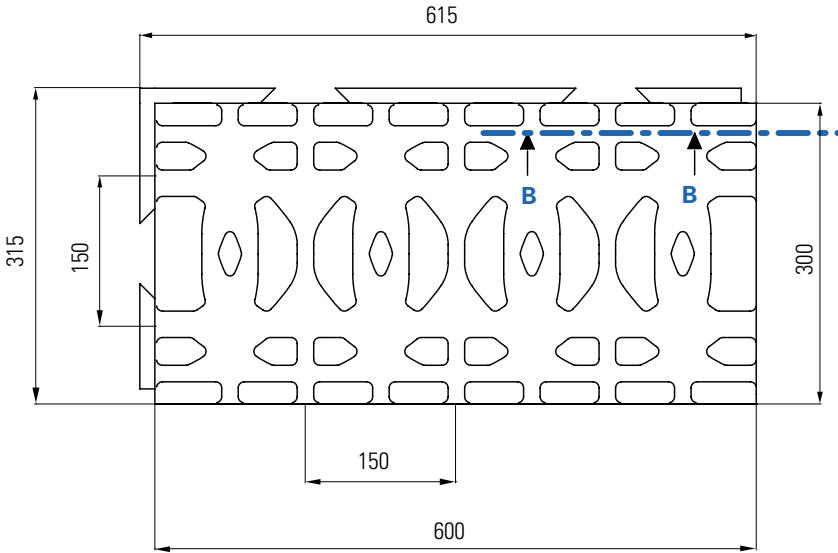

Pannello di testa /Head panel 1200 x 600 H 10

sezione/section B-B

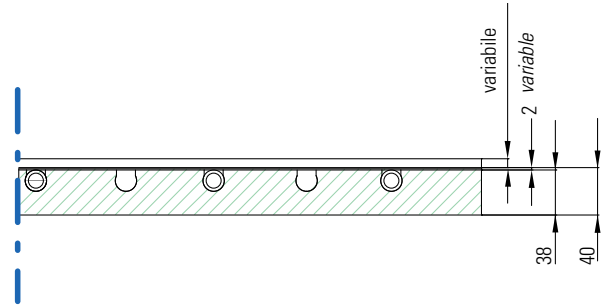
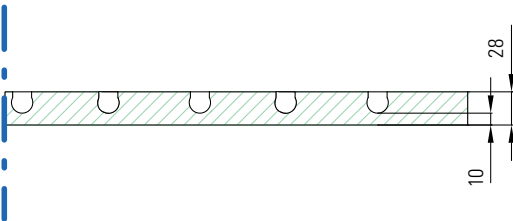

Pannello di testa /Head panel 600x300 H 20

sezione/section B-B

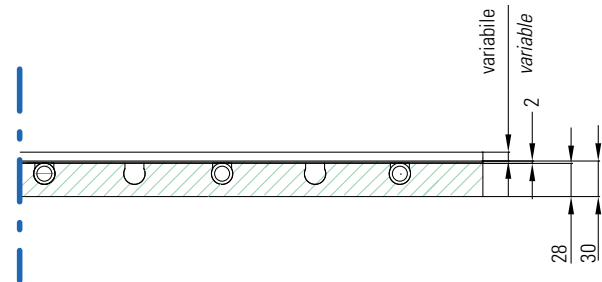
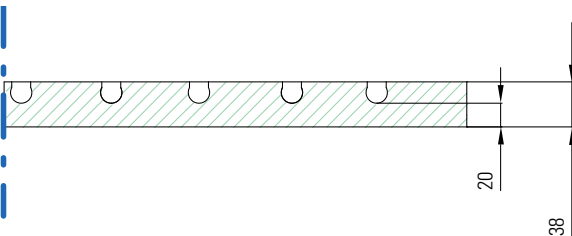

Ingombri minimi del sistema per edifici civili, con doppio strato di lamiera zincata per ripartizione carico (mm)
 Minimum system clearances for civil buildings with double layer of galvanized steel for load distribution (mm) (mm)

Ingombri minimi del sistema per edifici civili, con doppio strato di lamiera zincata per ripartizione carico (mm)
 Minimum system clearances for civil buildings with double layer of galvanized steel for load distribution (mm) (mm)